

DS-2CD1183G0-I 8 MP Fixed Dome Network Camera



- High quality imaging with 8 MP resolution
- Efficient H.265+ compression technology
- Clear imaging even with strong back lighting due to 120 dB WDR
- Water and dust resistant (IP67) and vandal resistant (IK10)
- EXIR 2.0: advanced infrared technology with long IR range



▪ Specification

Camera	
Image Sensor	1/2.8" Progressive Scan CMOS
Max. Resolution	3840 × 2160
Shutter Time	1/3 s to 1/100,000 s
Min. Illumination	Color: 0.01 Lux @ (F2.0, AGC ON), B/W: 0 Lux with IR
Day & Night	IR cut filter
Angle Adjustment	Pan: 0° to 355°, tilt: 0° to 75°
Lens	
Lens Type	Fixed focal lens, 2.8 and 4 mm optional
Focal Length & FOV	2.8 mm, horizontal FOV 108°, vertical FOV 60°, diagonal FOV 127° 4 mm, horizontal FOV 86°, vertical FOV 46°, diagonal FOV 102°
Lens Mount	M12
Iris Type	Fixed
Aperture	F2.0
DORI	
DORI	2.8 mm, D: 81 m, O: 32 m, R: 16 m, I: 8 m 4 mm, D: 106 m, O: 42 m, R: 21 m, I: 11 m
Illuminator	
Supplement Light Type	IR
Supplement Light Range	Up to 30 m
Smart Supplement Light	Yes
IR Wavelength	850 nm
Video	
Main Stream	50 Hz: 12.5 fps (3840 × 2160), 20 fps (2592 × 1944), 25 fps (2688 × 1520, 1920 × 1080, 1280 × 720) 60 Hz: 15 fps (3840 × 2160), 20 fps (2592 × 1944), 30 fps (2688 × 1520, 1920 × 1080, 1280 × 720)
Sub-Stream	50 Hz: 25 fps (1280 × 720, 640 × 480, 640 × 360) 60 Hz: 30 fps (1280 × 720, 640 × 480, 640 × 360)
Video Compression	Main stream: H.265+/H.264+/H.265/H.264 Sub-stream: H.265/H.264/MJPEG
Video Bit Rate	32 Kbps to 16 Mbps
H.264 Type	Baseline Profile/Main Profile/High Profile
H.265 Type	Main Profile
Bit Rate Control	CBR/VBR
Region of Interest (ROI)	1 fixed region for main stream

Network	
Security	Password protection, complicated password, HTTPS encryption, 802.1X authentication (EAP-MD5), watermark, IP address filter, basic and digest authentication for HTTP/HTTPS, WSSE and digest authentication for Open Network Video Interface, RTP/RTSP over HTTPS, security audit log, TLS 1.2, host authentication (MAC address)
Simultaneous Live View	Up to 6 channels
API	Open Network Video Interface (Profile S), ISAPI, SDK
Protocols	TCP/IP, ICMP, DHCP, DNS, DDNS, HTTP, HTTPS, RTP, RTSP, NTP, UPnP, IGMP, IPv6, UDP, QoS, Bonjour, FTP, 802.1x, SMTP
User/Host	Up to 32 users. 3 user levels: administrator, operator and user
Client	iVMS-4200, Hik-Connect
Web Browser	Plug-in required live view: IE 10, IE 11 Local service: Chrome 57.0+, Firefox 52.0+
Image	
Wide Dynamic Range (WDR)	120 dB
SNR	≥ 52 dB
Day/Night Switch	Day, Night, Auto, Schedule
Image Enhancement	BLC, HLC, 3D DNR
Image Settings	Rotate mode, saturation, brightness, contrast, sharpness, gain, white balance adjustable by client software or web browser.
Privacy Mask	4 regions of privacy mask
Interface	
Ethernet Interface	1 RJ45 10 M/100 M self-adaptive Ethernet port
Event	
Basic Event	Motion detection , video tampering alarm, exception
Linkage	Notify surveillance center, trigger capture
General	
Power	12 VDC ± 25%, 0.4 A, max. 5 W, Ø5.5 mm coaxial power plug PoE: 802.3af, Class 3, 36 V to 57 V, 0.2 A to 0.15 A, max. 6.5 W
Material	Metal & Plastic
Dimension	Ø110.8 mm × 84.7 mm (Ø4.4" × 3.3")
Package Dimension	134 mm × 134 mm × 108 mm (5.3" × 5.3" × 4.3")
Weight	Approx. 520 g (1.1 lb.)
With Package Weight	Approx. 720 g (1.6 lb.)
Storage Conditions	-30 °C to 60 °C (-22 °F to 140 °F). Humidity 95% or less (non-condensing)
Startup and Operating Conditions	-30 °C to 60 °C (-22 °F to 140 °F). Humidity 95% or less (non-condensing)
Language	English, Ukrainian
General Function	Anti-flicker, heartbeat, mirror, password protection, password reset via e-mail
Approval	
EMC	FCC (47 CFR Part 15, Subpart B) CE-EMC (EN 55032: 2015, EN 61000-3-2: 2019, EN 61000-3-3: 2013+A1: 2019, EN 50130-4: 2011+A1: 2014) RCM (AS/NZS CISPR 32: 2015) IC (ICES-003: Issue 7) KC (KN32: 2015, KN35: 2015)

Safety	UL (UL 62368-1) CB (IEC 62368-1: 2014+A11) CE-LVD (EN 62368-1: 2014/A11: 2017) BIS (IS 13252 (Part 1): 2010/IEC 60950-1: 2005)
Environment	CE-RoHS (2011/65/EU) WEEE (2012/19/EU) Reach (Regulation (EC) No 1907/2006)
Protection	IP67 (IEC 60529-2013) IK10 (IEC 62262: 2002)

▪ Available Model

DS-2CD1183G0-I (2.8/4 mm)

Typical Application

Hikvision products are classified into three levels according to their anti-corrosion performance. Refer to the following description to choose for your using environment.

This model has NO SPECIFIC PROTECTION.





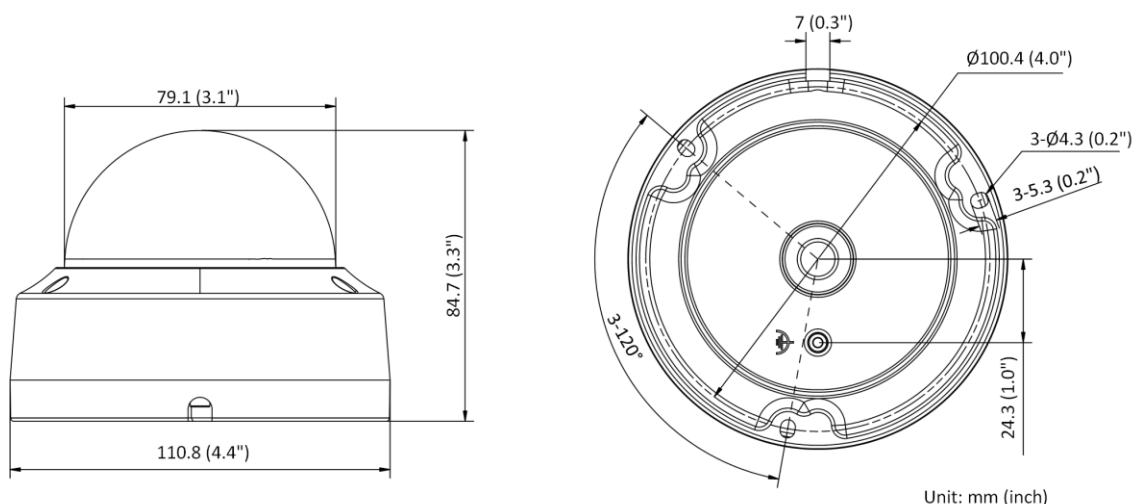

Level	Description
Top-level protection	Hikvision products at this level are equipped for use in areas where professional anti-corrosion protection is a must. Typical application scenarios include coastlines, docks, chemical plants, and more.
Moderate protection	Hikvision products at this level are equipped for use in areas with moderate anti-corrosion demands. Typical application scenarios include coastal areas about 2 kilometers (1.24 miles) away from coastlines, as well as areas affected by acid rain.
No specific protection	Hikvision products at this level are equipped for use in areas where no specific anti-corrosion protection is needed.

▪ Dimension



▪ **Accessory**

▪ **Optional**

<p>DS-1272ZJ-110B Wall Mount</p>	<p>DS-1280ZJ-DM18 Junction Box</p>	<p>DS-1276ZJ-SUS Corner Mount</p>	<p>DS-1271ZJ-110 Pendant Mount</p>	<p>DS-1272ZJ-110 Wall Mount</p>
				
<p>DS-1259ZJ Inclined Ceiling Mount</p>	<p>DS-1250ZJ Rain Shade</p>	<p>DS-1275ZJ-SUS Vertical Pole Mount</p>		
				

Distributed by

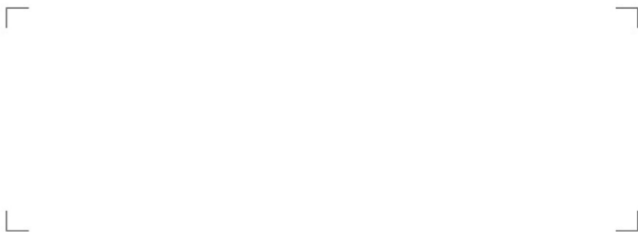
**HIKVISION®****Headquarters**

No.555 Qianmo Road, Binjiang District,
Hangzhou 310051, China
T +86-571-8807-5998
overseasbusiness@hikvision.com

Hikvision USA
T +1-909-895-0400
sales.usa@hikvision.com

Hikvision Australia
T +61-2-8599-4233
salesau@hikvision.com

Hikvision India
T +91-22-28469900
sales@pramahikvision.com

Hikvision Canada
T +1-866-200-6690
sales.canada@hikvision.com

Hikvision Thailand
T +662-275-9949
sales.thailand@hikvision.com

Hikvision Europe
T +31-23-5542770
sales.eu@hikvision.com

Hikvision Italy
T +39-0438-6902
info.it@hikvision.com

Hikvision Brazil
T +55 11 3318-0050
Latam.support@hikvision.com

Hikvision Turkey
T +90 (216)521 7070- 7074
sales.tr@hikvision.com

Hikvision Malaysia
T +601-7652-2413
sales.my@hikvision.com

Hikvision UK & Ireland
T +01628-902140
sales.uk@hikvision.com

Hikvision South Africa
Tel: +27 (10) 0351172
sale.africa@hikvision.com

Hikvision France
T +33(0)1-85-330-450
info.fr@hikvision.com

Hikvision Kazakhstan
T +7-727-9730667
nikia.panfilov@hikvision.ru

Hikvision Vietnam
T +84-974270888
sales.vt@hikvision.com

Hikvision UAE
T +971-4-4432090
salesme@hikvision.com

Hikvision Singapore
T +65-6684-4718
sg@hikvision.com

Hikvision Spain
T +34-91-737-16-55
info.es@hikvision.com

Hikvision Tashkent
T +99-87-1238-9438
uzb@hikvision.ru

Hikvision Hong Kong
T +852-2151-1761
info.hk@hikvision.com

Hikvision Russia
T +7-495-669-67-99
saleru@hikvision.com

Hikvision Korea
T +82-(0)31-731-8817
sales.korea@hikvision.com

Hikvision Poland
T +48-22-460-01-50
info.pl@hikvision.com

Hikvision Indonesia
T +62-21-2933759
Sales.Indonesia@hikvision.com

Hikvision Colombia
sales.colombia@hikvision.com